

**PLAN TECHNIQUE**

**PORTE COUPE FEU 60 - DOUBLE ACTION**

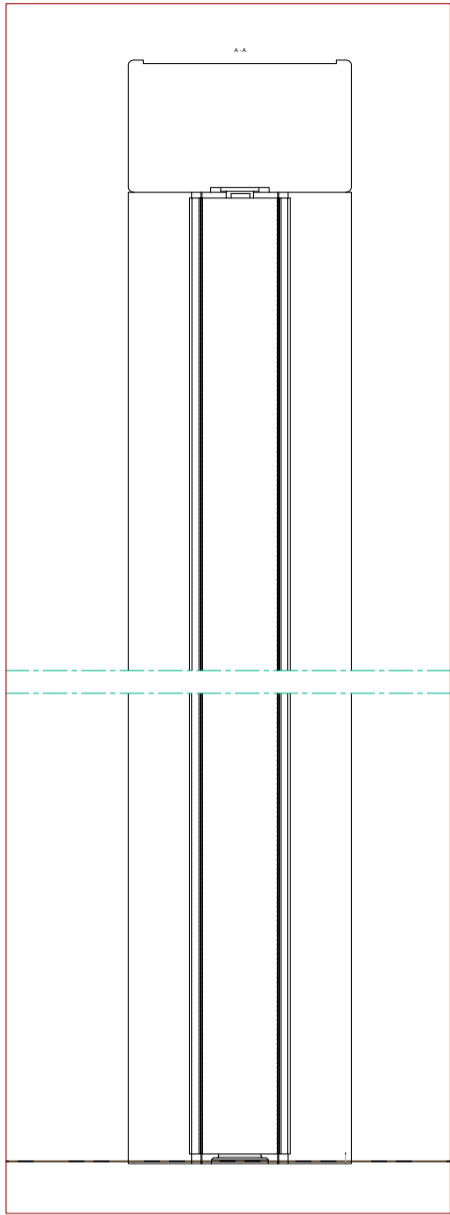

Coupe B-B' - Echelle 1/4

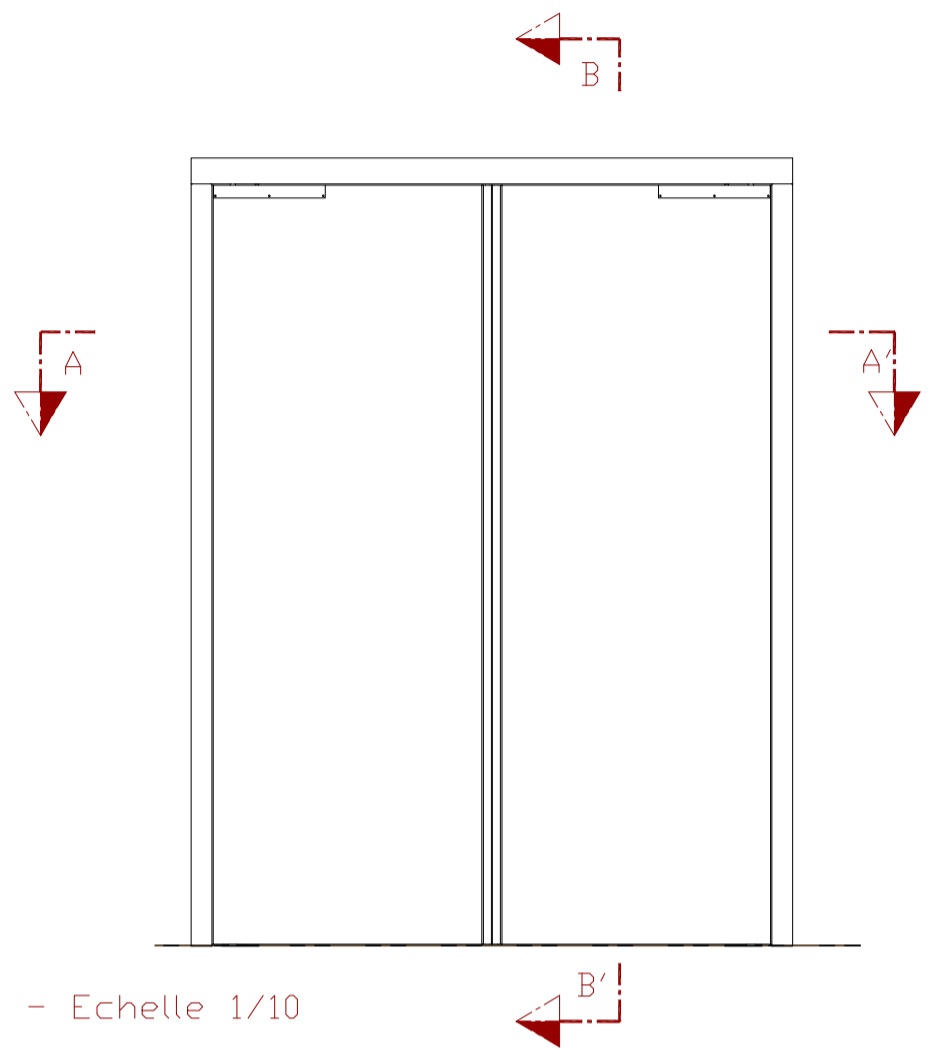

Élévation - Echelle 1/10

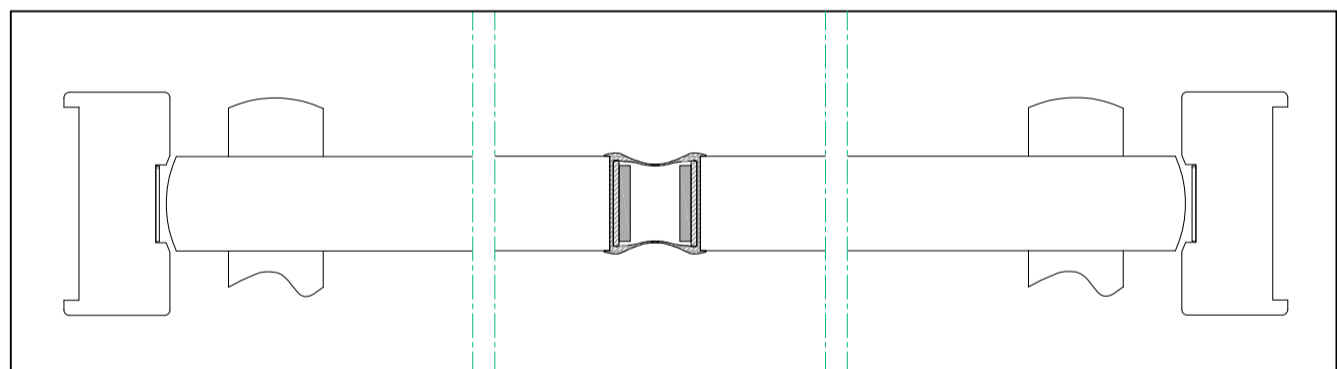

Coupe A-A' - Echelle 1/4

